

HKF1315

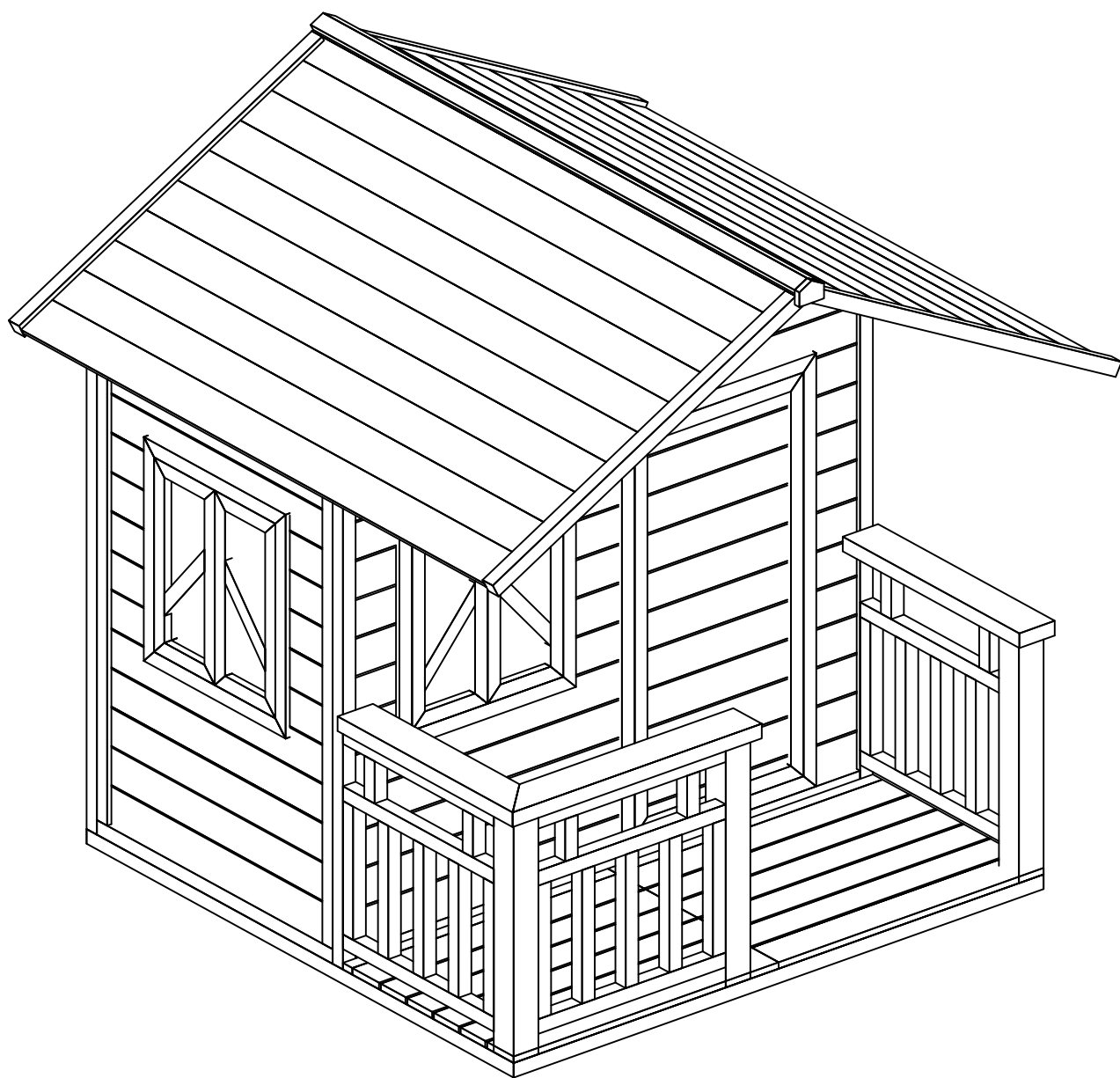

ART NO: 1315.01

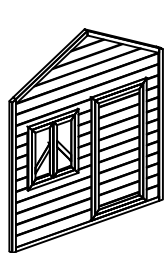

x1

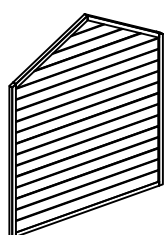

x1



x14



x7



x20
Φ 5*60

ART NO: 1315.02

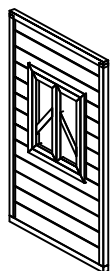

x2

ART NO: 1315.03

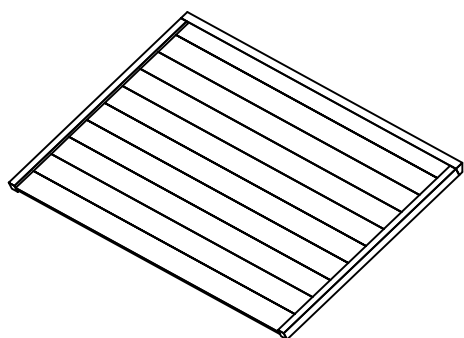

x2

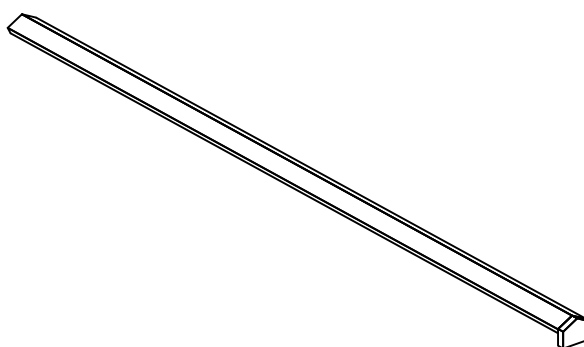

x1

ART NO: 1315.04

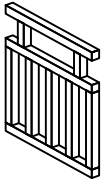

x3

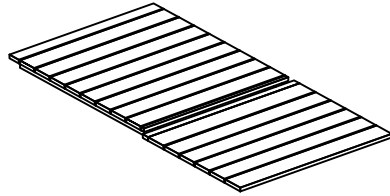

x2

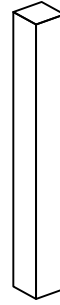

x3

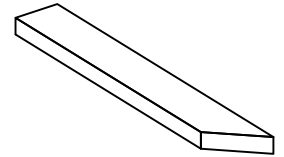

x2

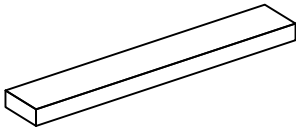

x1

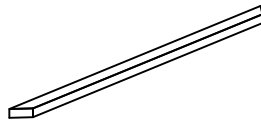

x4

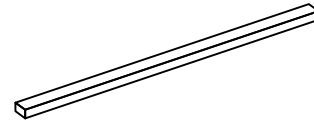

x1



x8
Φ 5*40



x18
Φ 5*60

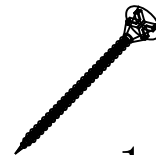

x18
Φ 5*70

